



▼ KAL-T308



▶ KIP-304

Multi Audio Doorphone System

3 + n wire connection



KOCOM new

**Multi Audio
Doorphone System**

Marketing Points

**Slim Design
easy installation**

**security alarm
function**

**surface
mount
28mm
Depth**

**clean
& loud
Voice
(2way)**

**long
distance**

**door
open**

**easy & convenient
volume control**

**multi
application**

Item List

■ ■ KAL series (Audio Lobbyphone)



KAL-S302



KAL-S303



KAL-S304



KAL-T306



KAL-T308

■ ■ KEL series (Extension Unit)



KEL-A308



KEL-AT316

■ ■ KIP-304 (Interphone)



DoorOpen
Button



“ Multiple Apartment, Villa, Office
Condominium, Bank and Hospital. ”

1. Easy Installation

3 Wires in Common

 Including Door Lock Connection

& 1 separate wire
for each apartment

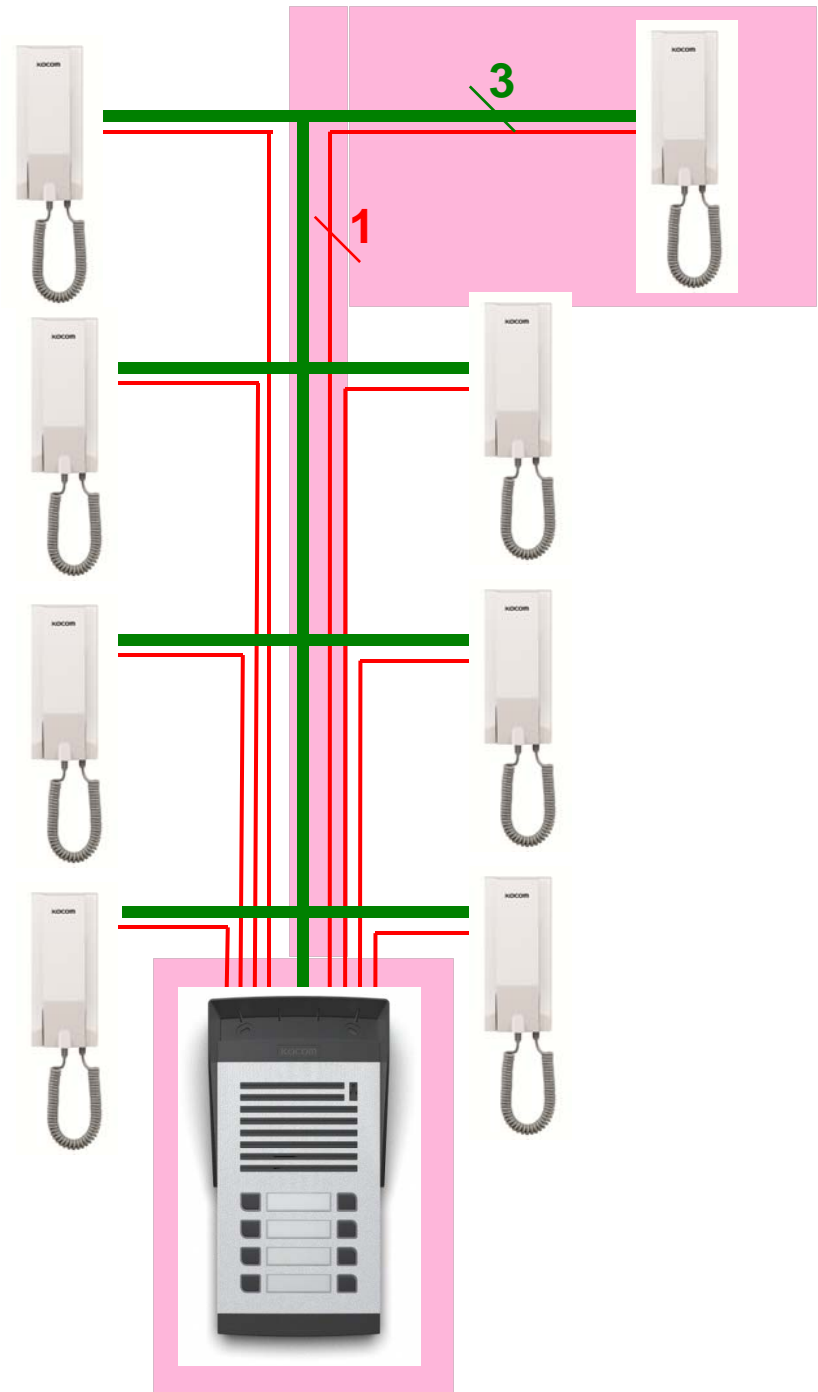

2. Door Opener Connection direct to Lobbyphone

If you connect Door Opener direct to Lobbyphone,

'Door Open' function is available from all the Interphones connected to the Lobbyphone.

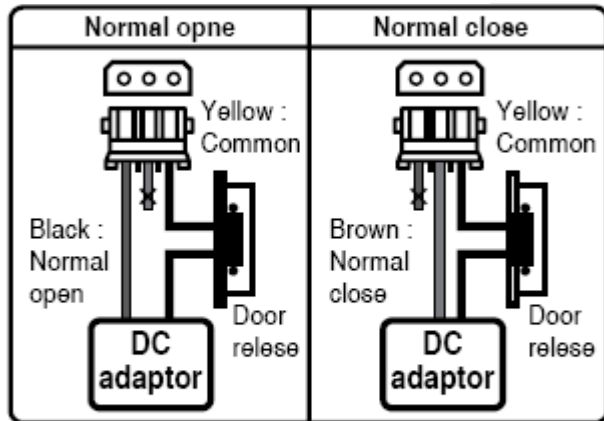

Door opener 2 is output in N.O / N.C and is used in connection in compliance with door release specification.

* According to Door Lock type, both 'Normal Open' and 'Normal Close' are available.

3. Security Alarm (optional) Connection Available

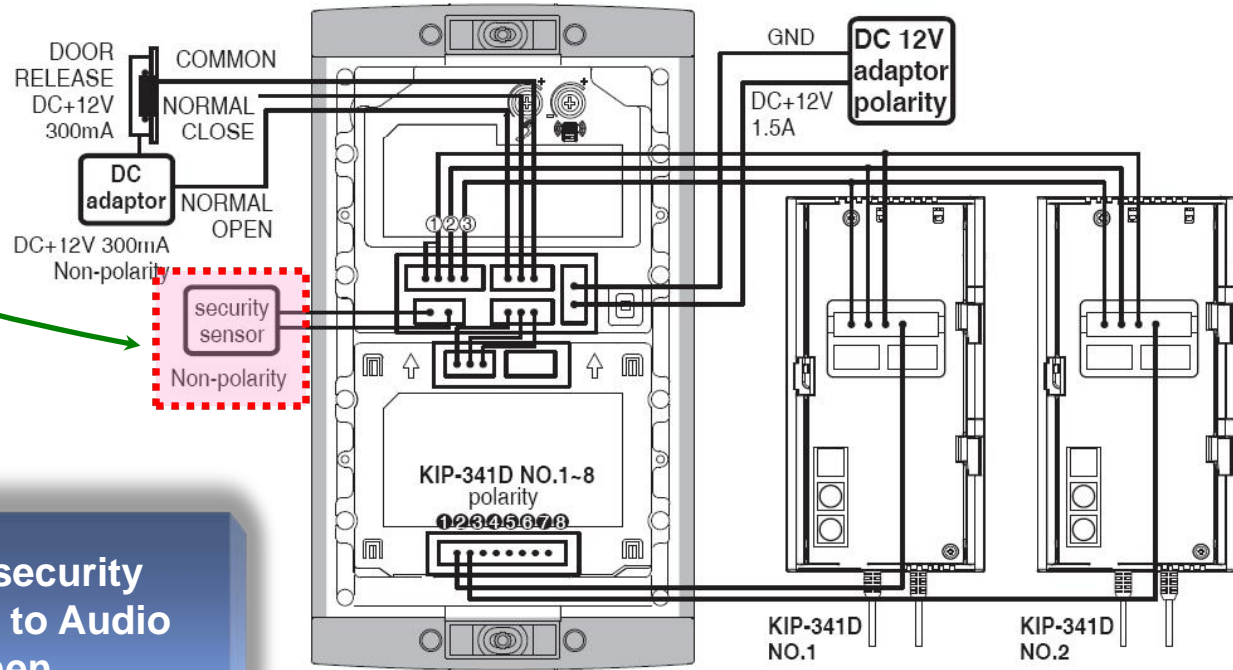

If you connect a security sensor (optional) to Audio Lobby Phone, when someone breaks the Lobby Phone open, it makes sounds.



4. Slim Design

28mm Depth

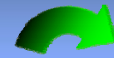

Surface Mount

KOCOM

5. Clear & Loud Voice Messenger by 2-way communication method



2 way
mutual communication



'door open' button
Is located under the handset



6. Long Distance Connection

* using CAT5 cable, up to 300m distance



* last (the farthest) unit



KOCOM

7. Easy and Convenient Volume Control

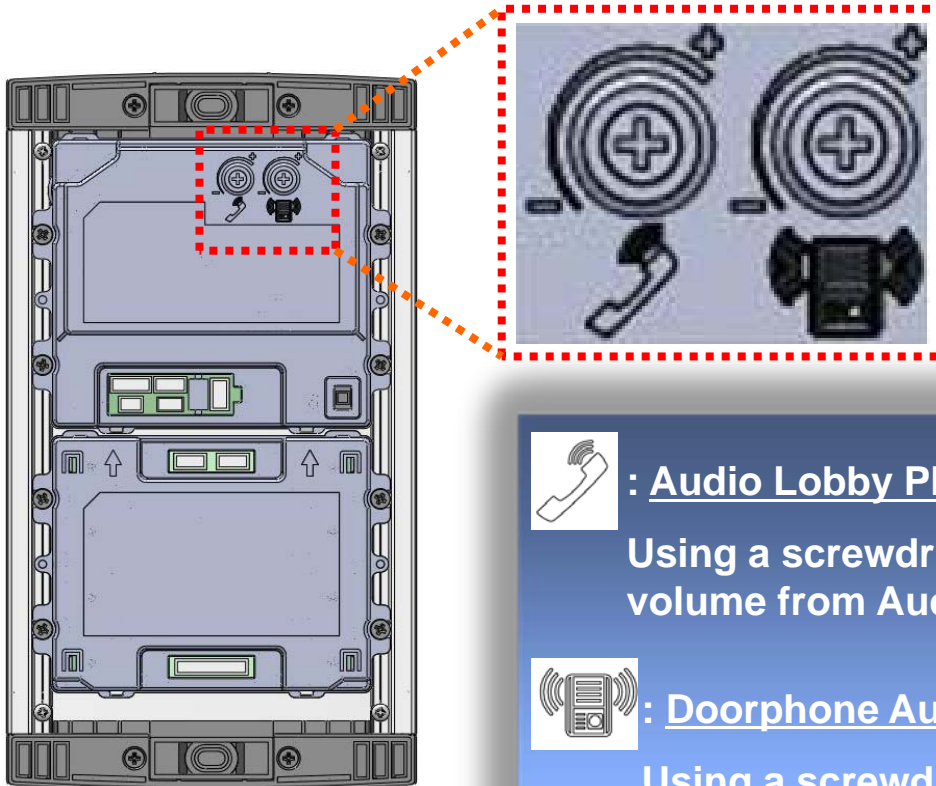

: Audio Lobby Phone -> Doorphone Audio Volume

Using a screwdriver, increase(+) or decrease(-) the volume from Audio Lobby Phone to Doorphone



: Doorphone Audio Volume -> Audio Lobby Phone

Using a screwdriver, increase(+) or decrease(-) the volume from Doorphone to Audio Lobby Phone

8. Easy Connection

Using Wafer Connectors

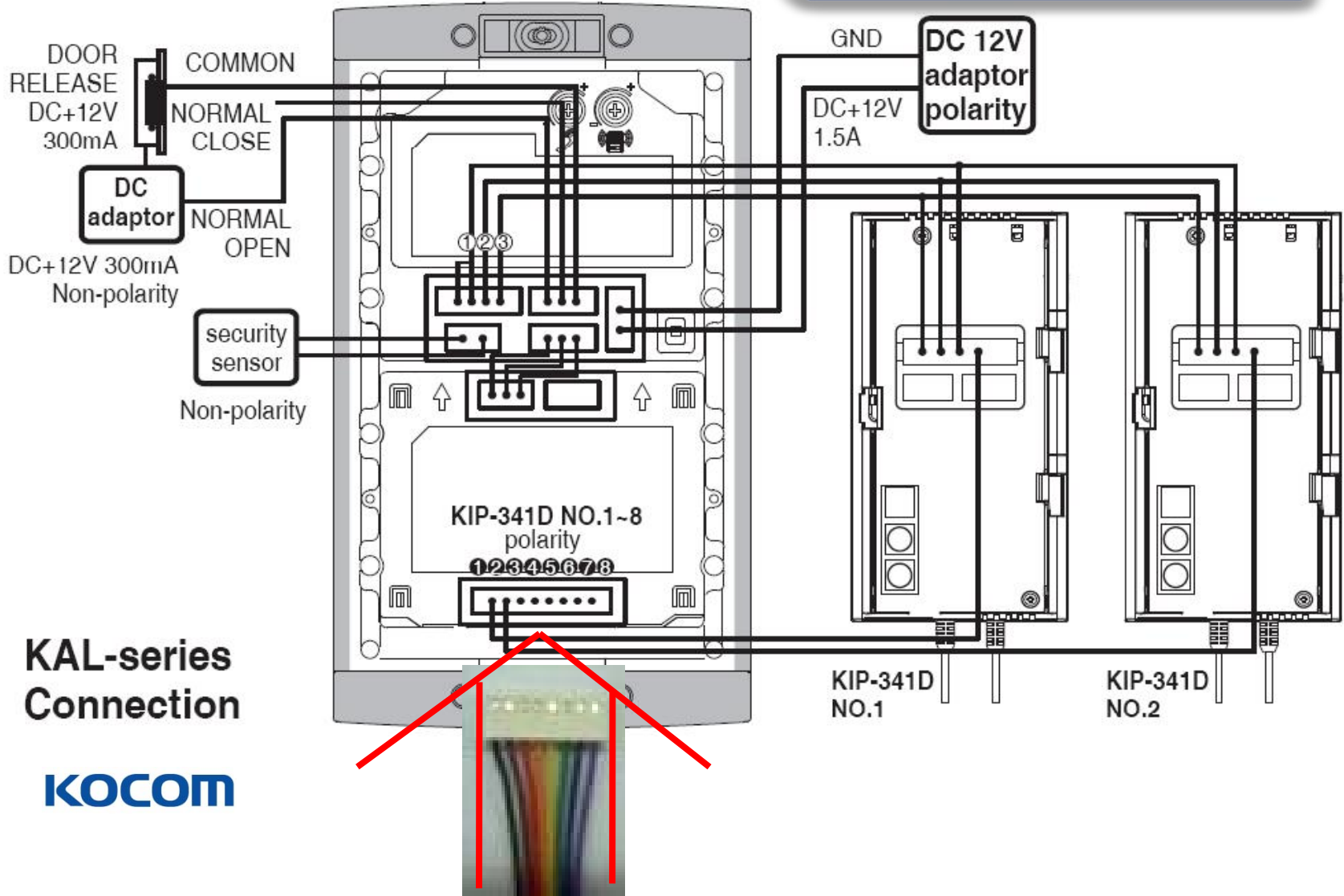

9. Multi-Application

System configuration



2 buttons



3 buttons



4 buttons

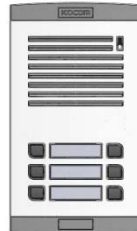

6 buttons

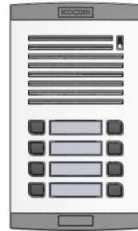

8 buttons



10 buttons

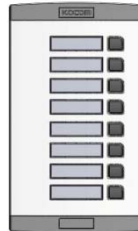

11,12,14,16

...



18 buttons

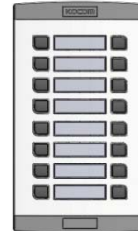

...



19,20,22,24

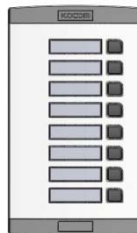

26 buttons

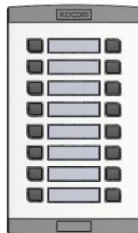

27,28,30,32

...

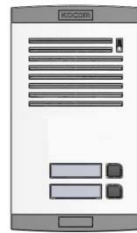

34 buttons

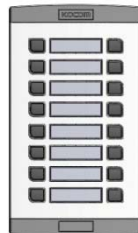

36,38

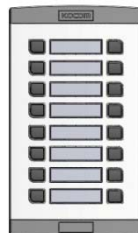

...

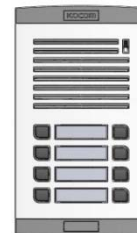

40 buttons max.

